

DWG02 : FRL -/90/- Fire Rated Installation

Note: See DWG12 for fixing detail

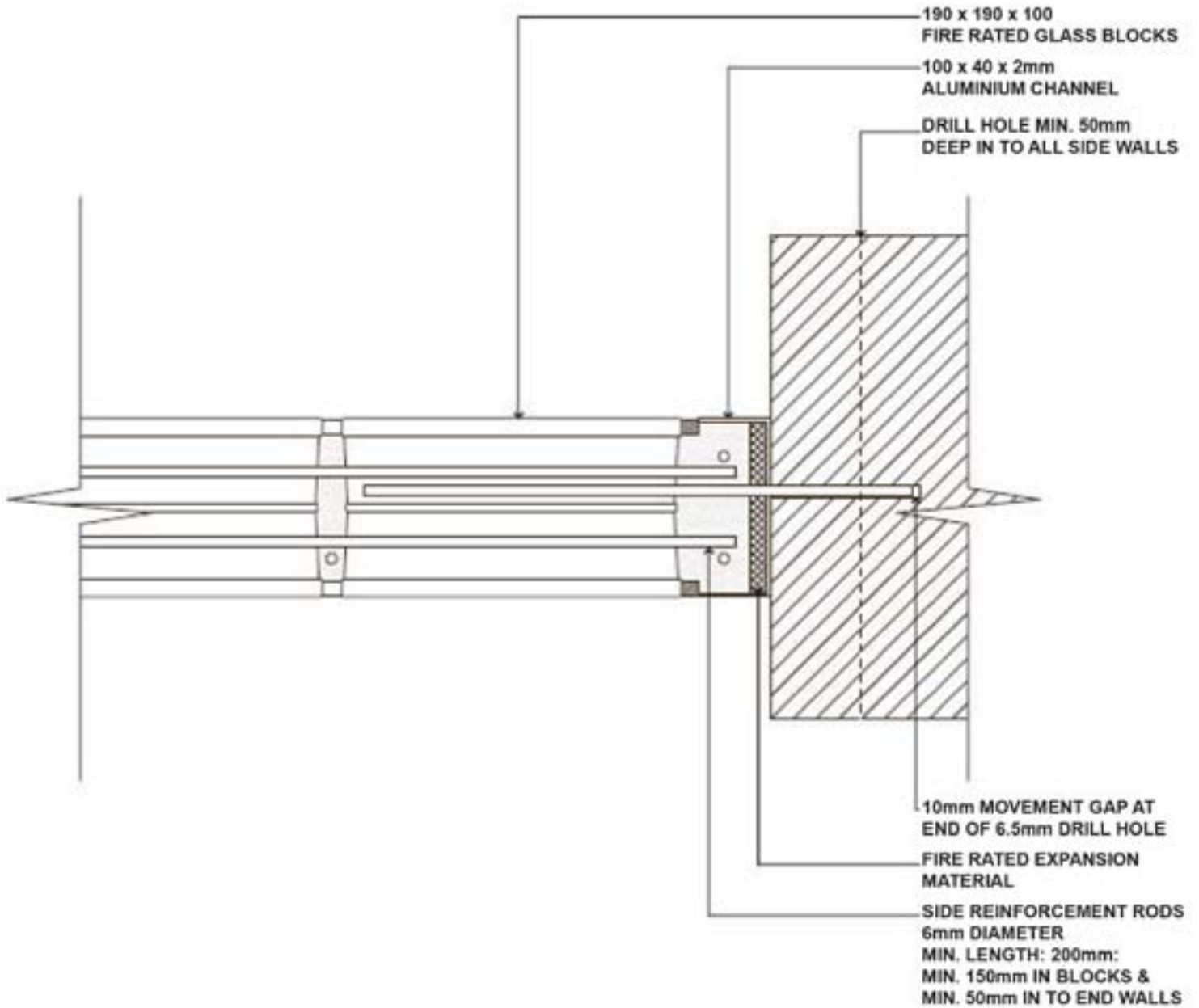

DWG12 : FRL -/90/- Fire Rated Fixing Detail